

Switching diode

• **Applications**

High speed switching

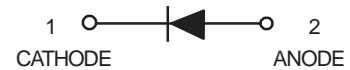

• **Features**

- 1) Extremely small surface mounting type.
- 2) High Speed.
- 3) High reliability.

• **Construction**

Silicon epitaxial planar

- We declare that material of product compliance with ROHS requirements.

ABSOLUTE MAXIMUM RATINGS (Ta = 25°C)

Parameter	Symbol	Limits	Unit
Peak reverse voltage	V_{RM}	90	V
DC reverse voltage	V_R	80	V
Peak forward current	I_{FM}	225	mA
Mean rectifying current	I_o	100	mA
Surge current (1s)	I_{surge}	500	mA
Junction temperature	T_J	150	°C
Storage temperature	T_{slg}	- 55 ~ +150	°C

ELECTRICAL CHARACTERISTICS (Ta = 25°C)

Parameter	Symbol	Min.	Typ.	Max.	Unit	Conditions
Forward voltage	V_F	-	-	1.2	V	$I_F=100mA$
Reverse current	I_R	-	-	0.1	μA	$V_R=80V$
Capacitance between terminals	C_T	-	0.72	3.0	pF	$V_R=0.5V, f=1MHz$
Reverse recovery time	t_{rr}	-	-	4	ns	$V_R=6V, I_F=10mA, R_L=100 \ \Omega$

ORDRING INFORMATION

Device	Marking	Shipping
MEW400-D5-G	A	3000/Tape&Reel



ELECTRICAL CHARACTERISTIC CURVES

($T_a = 25^\circ\text{C}$)

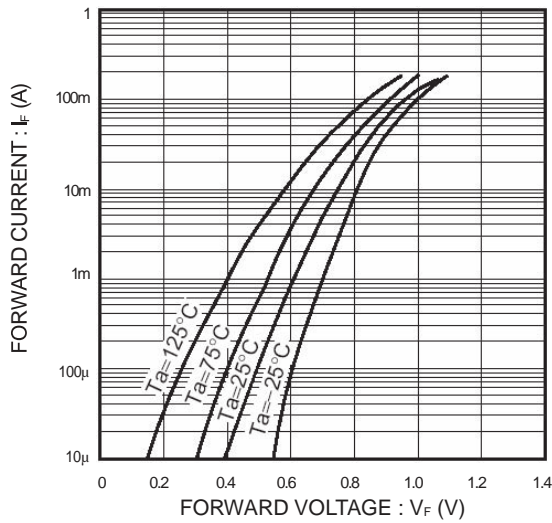

Fig.1 Forward characteristics

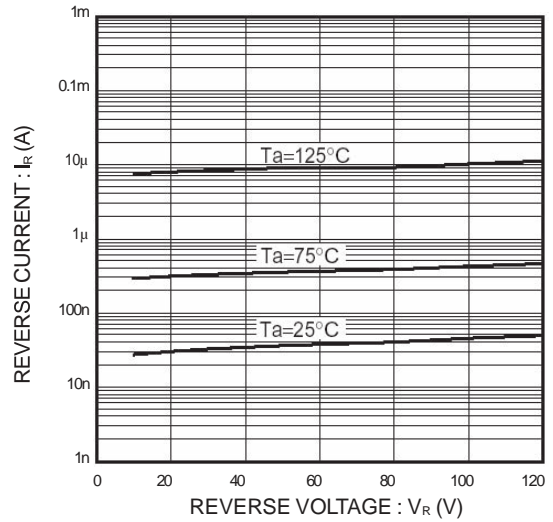

Fig.2 Reverse characteristics

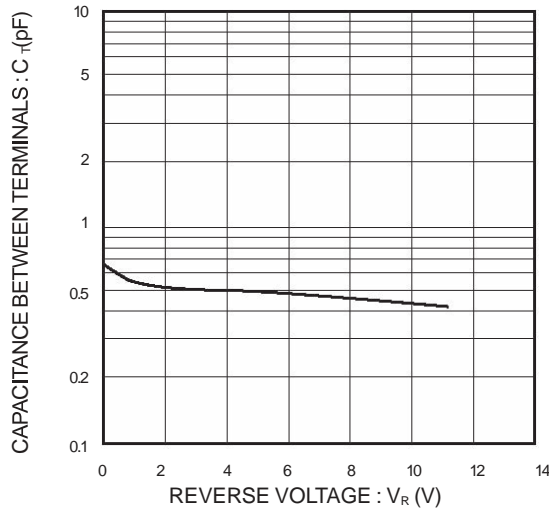

Fig.3 Capacitance between terminals

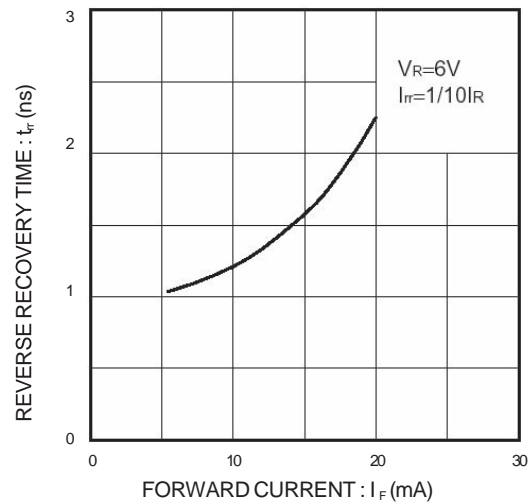

Fig.4 Reverse recovery time characteristics

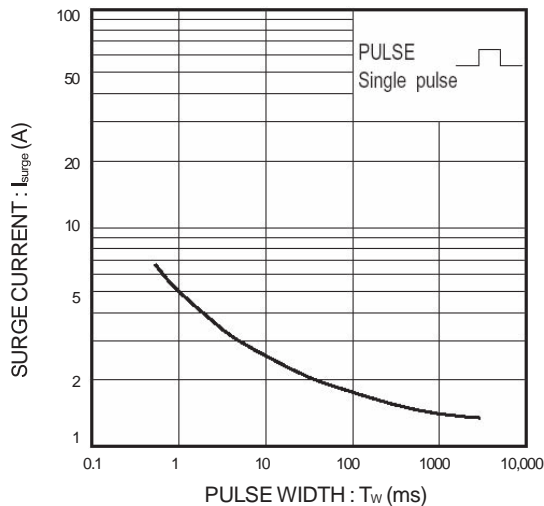

Fig.5 Surge current characteristics

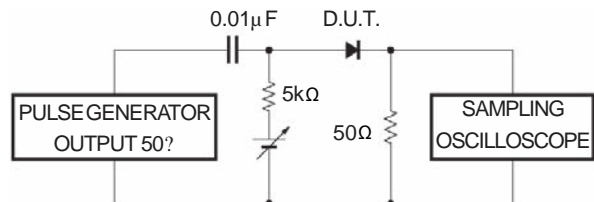
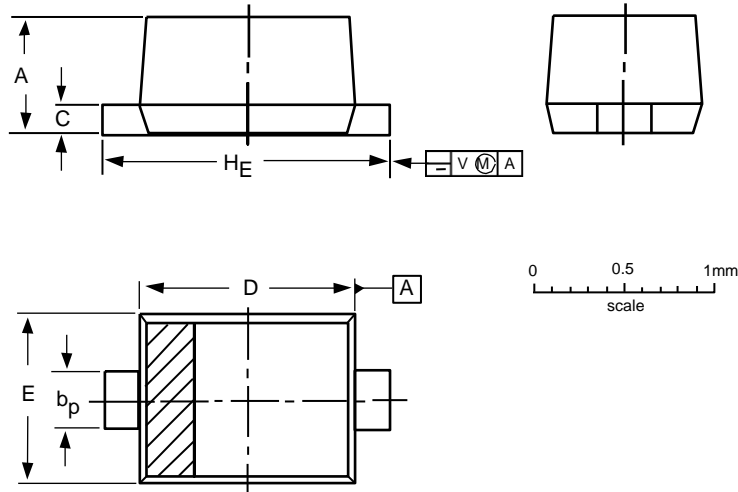

Fig.6 Reverse recovery time (t_{rr}) measurement circuit



SOD-523



DIMENSIONS (mm are the original dimensions)

UNIT	A	b _p	c	D	E	H _E	V
mm	0.7	0.35	0.2	1.3	0.9	1.7	0.15
	0.5	0.25	0.1	1.1	0.7	1.5	

Note

1. The marking bar indicates the cathode.

OUTLINE VERSION	REFERENCES			EUROPEAN PROJECTION	ISSUE DATE
	IEC	JEDEC	EIAJ		
SOD523			SC-79		98-11-25

